

EXTRUSION PROFILE

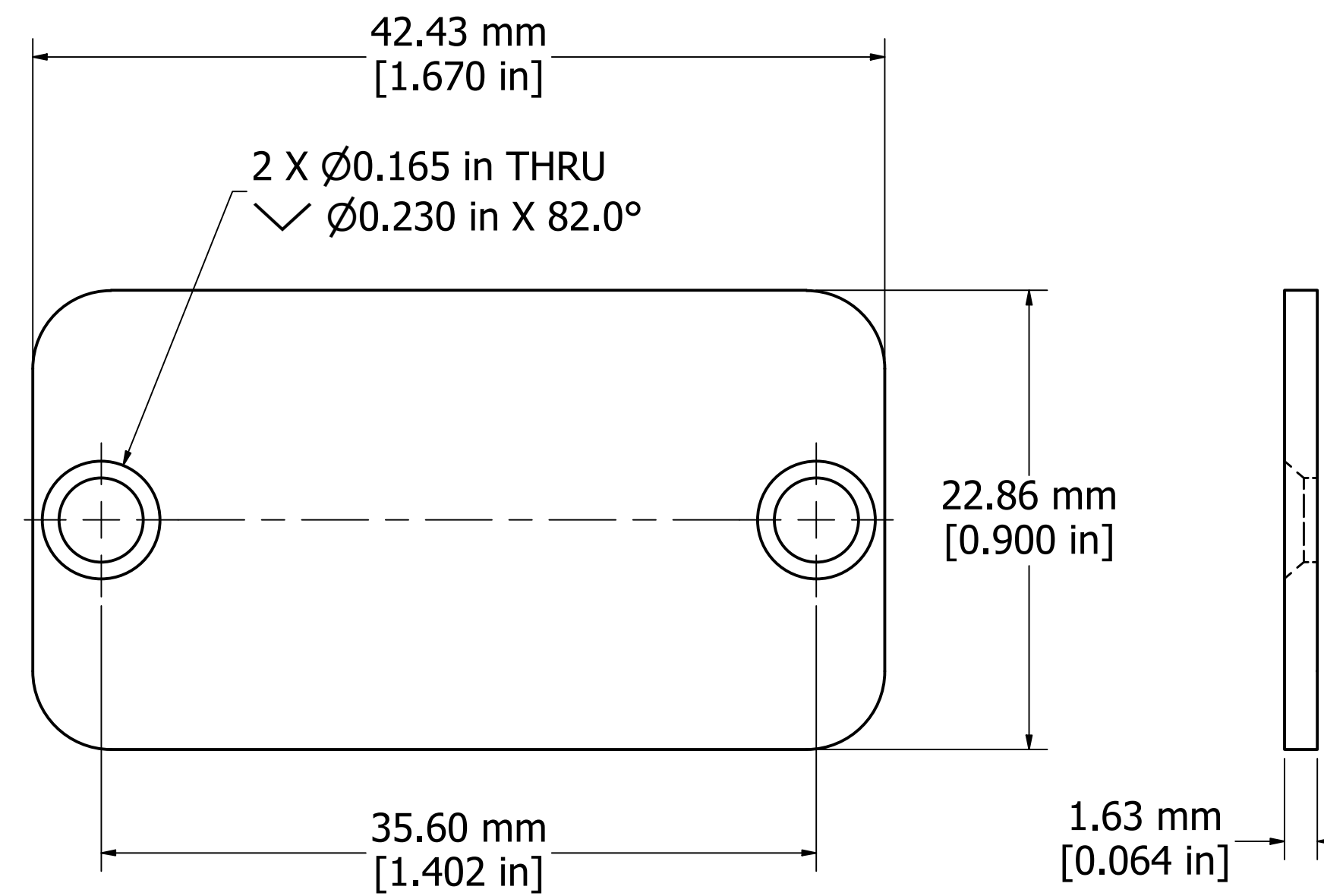

ENDPLATE

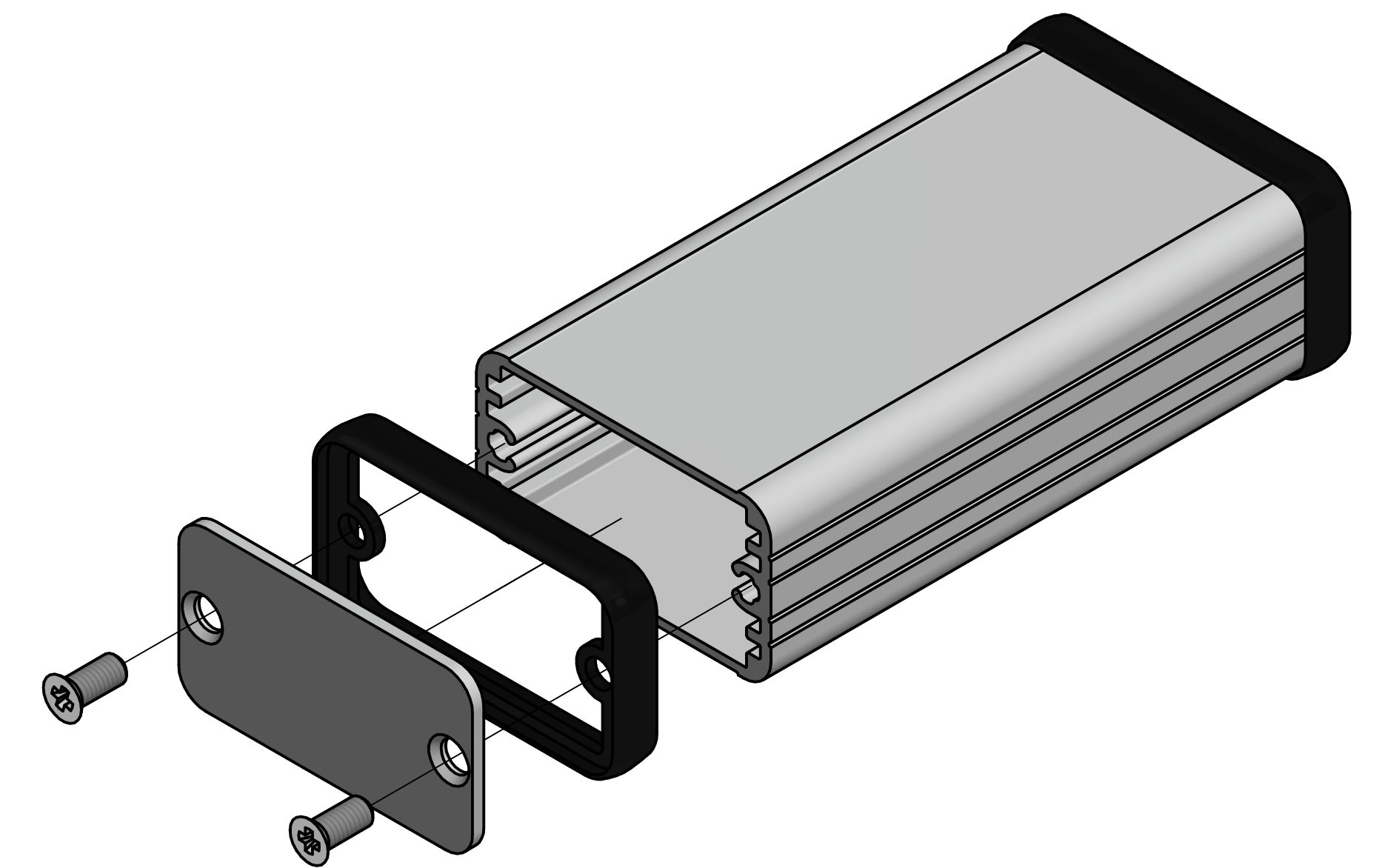

EXPLODED ASSEMBLY VIEW

****DESIGNED FOR 39MM WIDE PC BOARD****

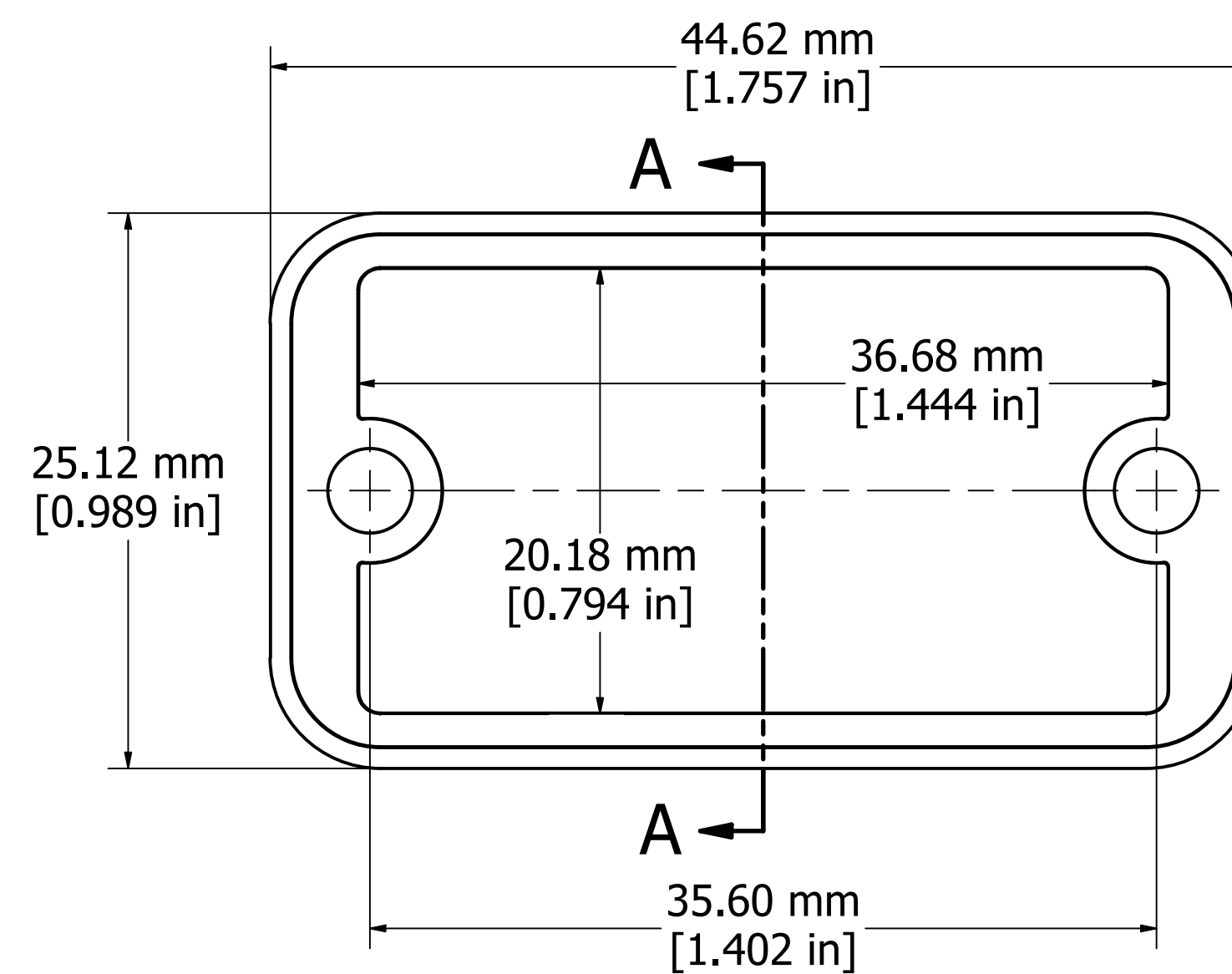
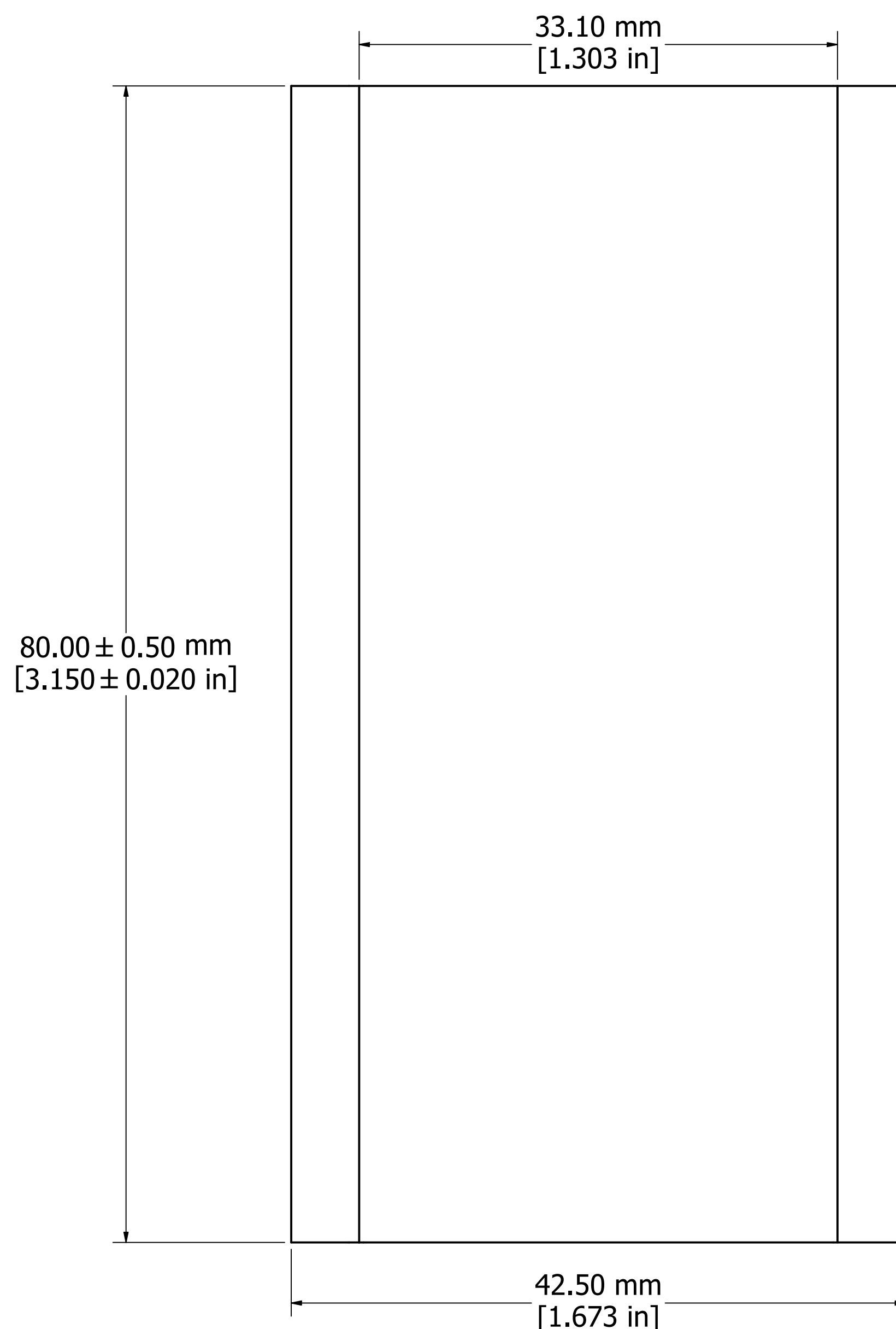

OPEN BEZEL

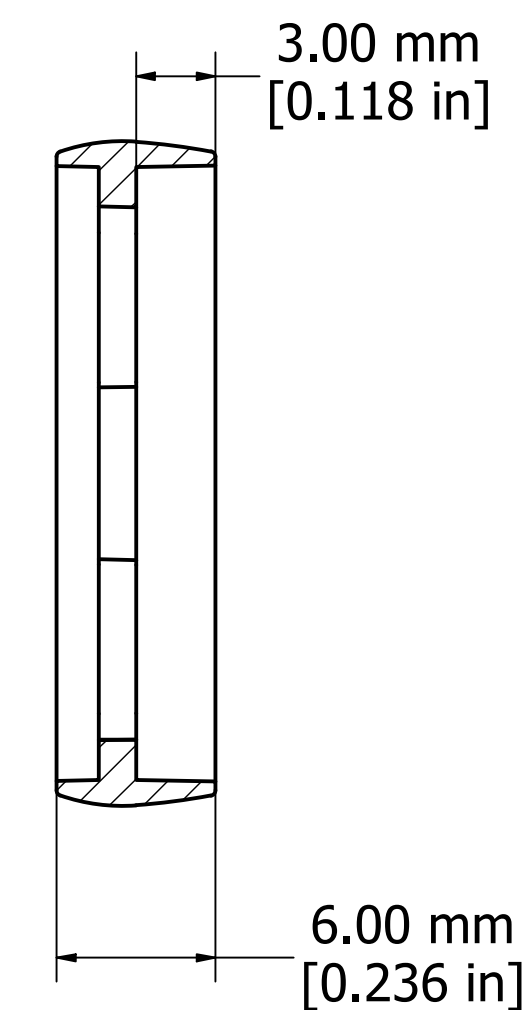

SECTION A-A

Enclosures can be Factory Modified (Milling, Drilling, Printing etc.)
 Contact Factory mjm@hammondmfg.com for quotes
 Solid models of this enclosure available in STEP or IGES.

NOTE	
Purchased assembly includes box, plastic bezels, End Panels, Custom #6 Taptight screws and self adhesive rubber feet	
Box made from Extruded Aluminum 6063-T5	
Bezels made with polycarbonate.	
End Plates made from 5052-H32 Aluminum	
1455D801	
PART NUMBERS	
Clear Anodized	1455D801
Black Anodized	1455D801BK
Blue Anodized	1455D801BU
Red Anodized	1455D801RD
ACCESSORIES	
See website for accessories.	



**HAMMOND
MANUFACTURING™**

1455D801

www.hammondmfg.com