

**TOP VIEW**

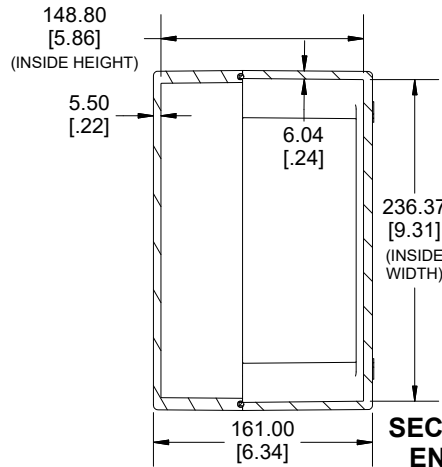

**SECTION B-B  
END VIEW**

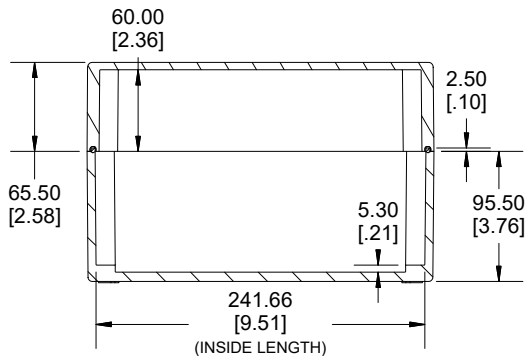
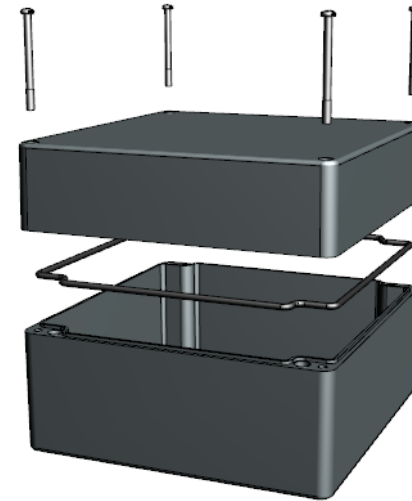

**SECTION A-A  
SIDE VIEW**

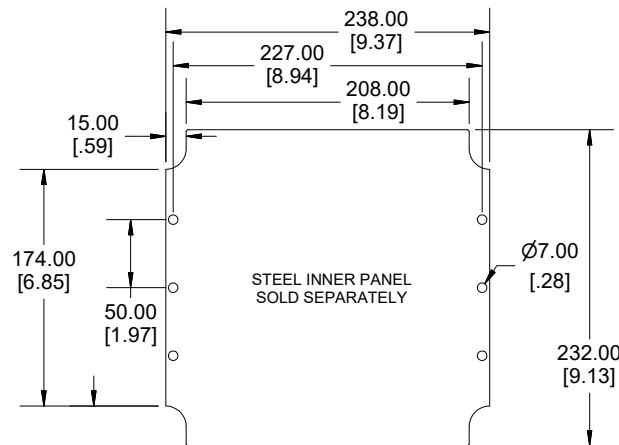

STEEL INNER PANEL  
SOLD SEPARATELY

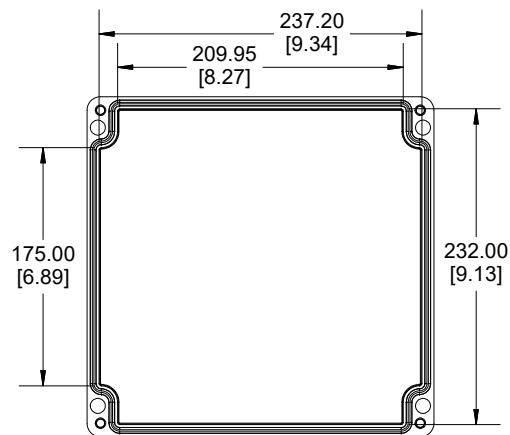

**INSIDE LID**

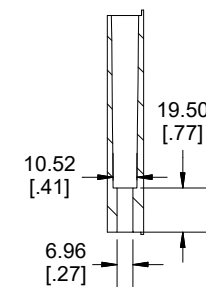

**SECTION C-C  
MOUNTING HOLE**

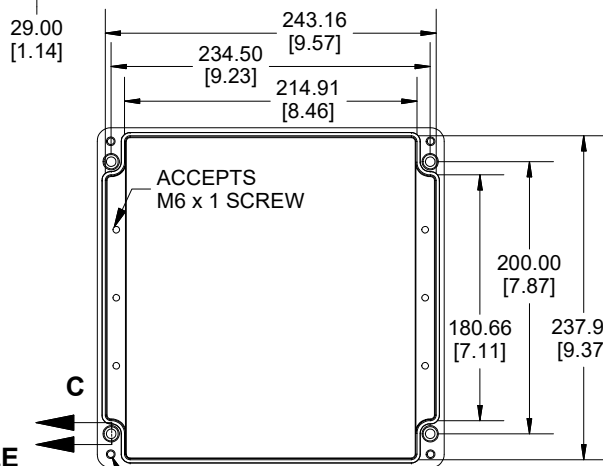

**INSIDE BOX**

Dimensions:  
mm  
[inches]



Enclosures can be Factory Modified (Milling, Drilling, Printing etc.)  
Contact Factory (modshop@hammfg.com) for quotes  
Solid models of this enclosure available in .stp or .x\_t  
(Part number and text placement/orientation on our products are subject to change,  
we do not recommend using them as a locating reference for modification purposes)

NOTE	
Purchased assembly includes Box, Lid, Gasket and 4 cover screws	
Enclosure Molded from Glass Reinforced Polyester	
<b>Recommended cover screw torque 13.3-17.7 lbf.in (150-200 cN.m)</b>	
PART NUMBERS	
1590ZGRP235 Enclosure	
Black Enclosure	1590ZGRP235BK
ACCESSORIES	
Copper Ground Hardware (20 Pack) [M6 - 1.0 X 6mm / M6 Washer]	SCGM6GRP-20
Stainless Steel Cover Screw (12 Pack) [M6 - 1.0 x 70mm]	SC571-12
Steel Inner Panel	1590ZGRP234PL
Hinge Kit Black (2 Pack)	1427HKBK

**HAMMOND  
MANUFACTURING®**  
**1590ZGRP235BK**  
www.hammondmfg.com