

TOP VIEW

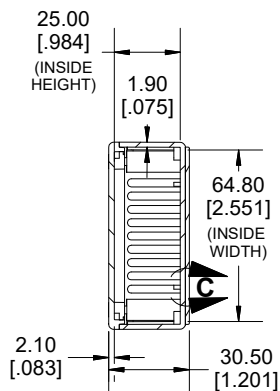

SECTION A-A

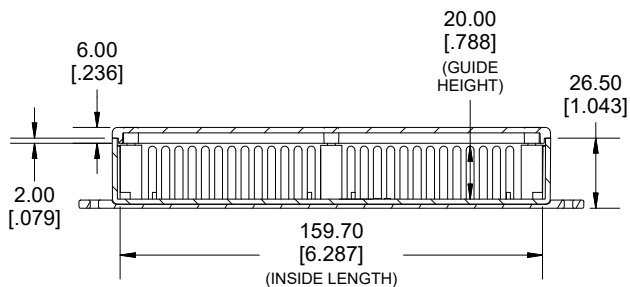
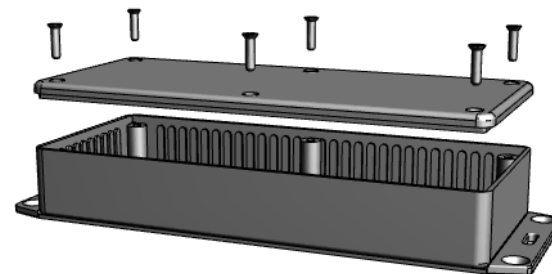

**SECTION B-B
SIDE VIEW**

DETAIL C

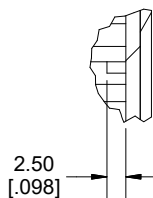

DETAIL D

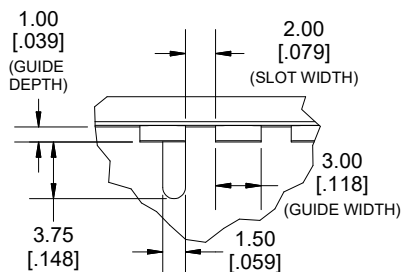

Enclosures can be Factory Modified (Milling, Drilling, Printing etc.)
 Contact Factory (modshop@hammfg.com) for quotes
 Solid models of this enclosure available in .stp or .x_t
 (Part number and text placement/orientation on our products are subject to change,
 we do not recommend using them as a locating reference for modification purposes)

NOTE

Purchased assembly includes box, lid and 6 cover screws
 Enclosure made from GPABS.

Recommended Torque: 42-57 ozf.in (30-40 cN.m)

PART NUMBERS

1591H Enclosure

General Purpose ABS Black	1591HF2SBK
General Purpose ABS Grey	1591HF2SGY

Accessories

Plated Cover screw	1591TS100 (Silver)
#4 X 1/2" (100Pkg) Self-Tapping	1591TS100BK (Black)
	1591Z6 (6Pkg)
PC Board Card Adapters	1591Z50 (50 Pkg)
	1591Z100 (100Pkg)
Nylon Belt / Pocket clip	1599CLIP (Black)
	1599CLIPGY (Grey)
Clear Lids - Flame Retardant	1591HC
Polycarbonate - Lid ONLY	

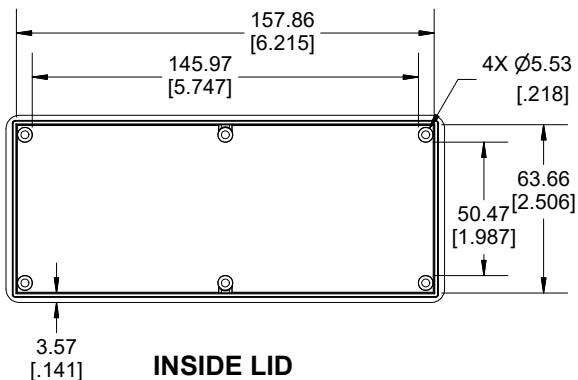

INSIDE LID

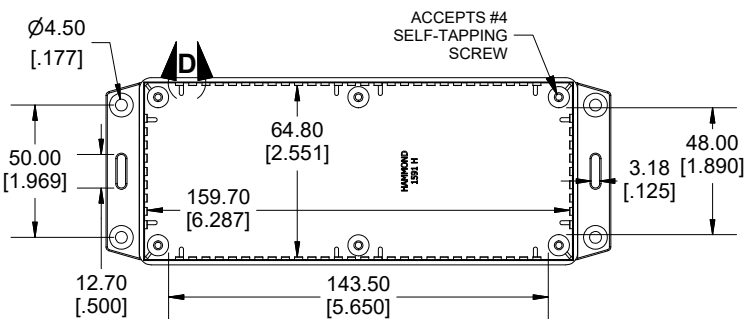

INSIDE BOX

Dimensions:
 mm
 [inches]

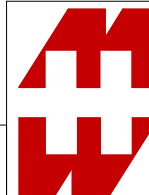

**HAMMOND
 MANUFACTURING.**

1591HF2S

www.hammondmfg.com