

TOP VIEW

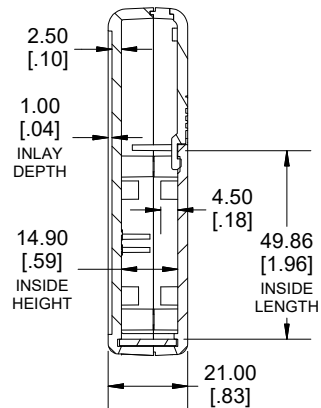

SECTION B-B
 SIDE VIEW

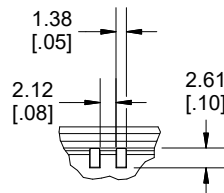

DETAIL C

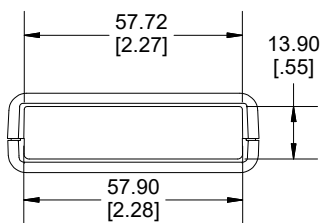
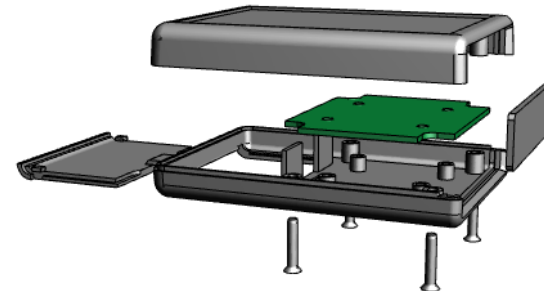

END VIEW

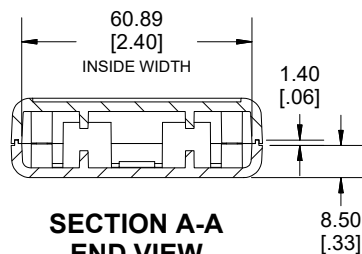

SECTION A-A
 END VIEW

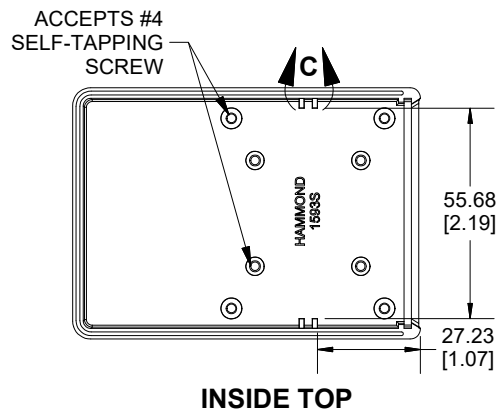

INSIDE TOP

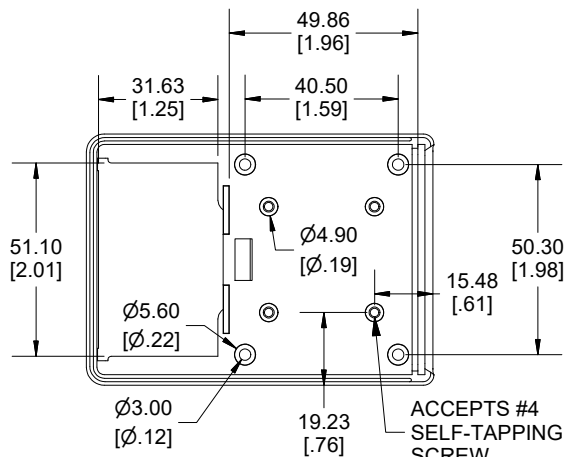

INSIDE BOTTOM

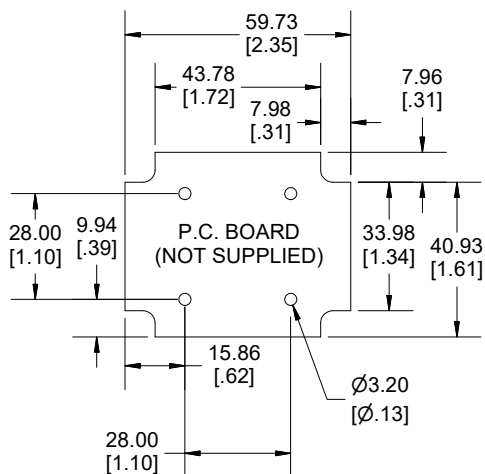

Dimensions:
 mm
 [inches]

Enclosures can be Factory Modified (Milling, Drilling, Printing etc.)
 Contact Factory (modshop@hammfg.com) for quotes
 Solid models of this enclosure available in .stp or .x_t
 (Part number and text placement/orientation on our products are subject to change,
 we do not recommend using them as a locating reference for modification purposes)

NOTE		
Enclosure molded from GP ABS (UL94-HB) plastic.		
Purchased assembly includes top and bottom cover, 1 plastic flat panel for front, battery door and 4 cover screws.		
Recommended Cover Screw Torque - 57lbf-in (40cN-m)		
1593		
1593S Regular Enclosure		
Black Enclosure	1593SBK	
Grey Enclosure	1593SGY	
Translucent Blue Enclosure	1593STBU	
ACCESSORIES		
Cover Screws #4 X 5/8" Self-Tapping (100 Pkg)	1593MS100 (Silver)	
	1593MS100BK (Black)	
P.C. Board Screws #4 X 1/4" Self-Tapping	1593ATS50 (Pkg 50)	
	1593ATS100 (Pkg 100)	
Nylon Belt Clip	1599CLIP (Black)	
	1599CLIPGY (Grey)	
1-AAA Battery Holder (Single)	BH1AAAW	
2-AAA Battery Holder (Single)	BH2AAAW	
1593S STD FLAT PANEL (SINGLE PANEL)	Black	1593SLBK-BULK
	Grey	1593SLGY-BULK
	Translucent Blue	1593SLTBU-BULK
	Infrared	1593SIR10
	Aluminum	1593SAL10

HAMMOND MANUFACTURING
 1593S
 www.hammondmfg.com