

SECTION B-B

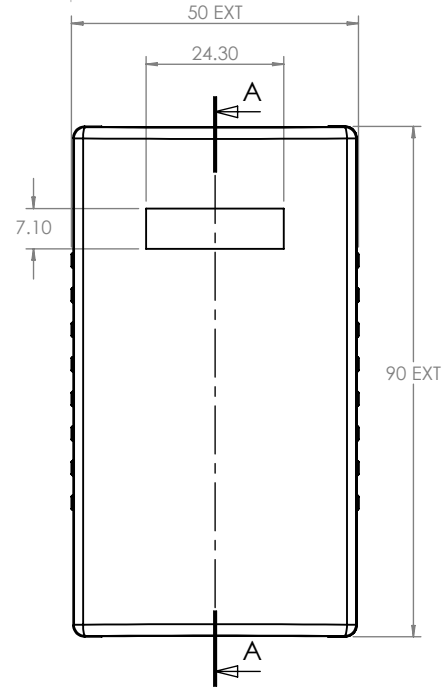

SECTION A-A

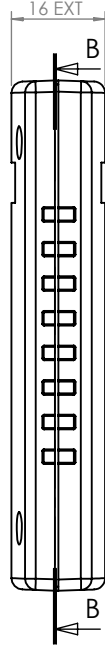
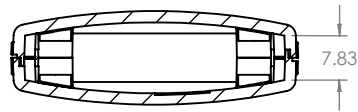
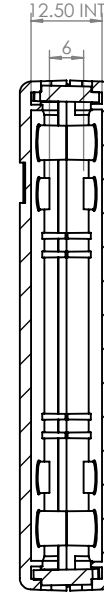

SECTION C-C

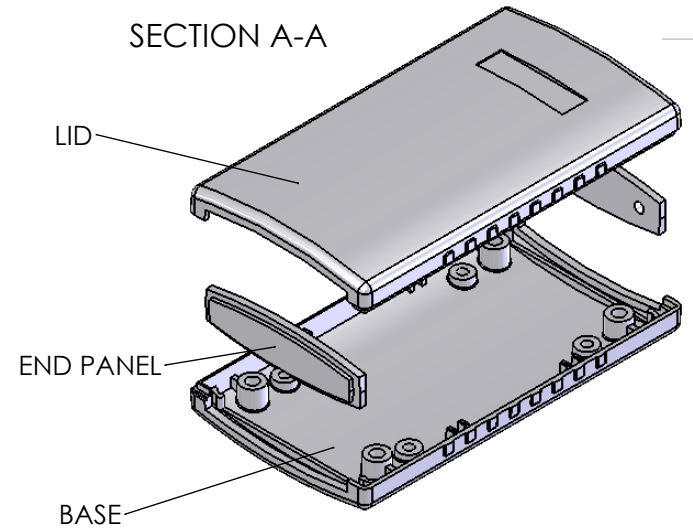
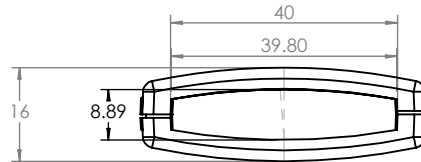

 CAMDENBOSS JAMES CARTER RD, MILDENHALL, SUFFOLK. IP28 7DE TEL: 01638 716101 FAX: 01638 716554 EMAIL: Sales@CamdenBoss.com WEB: www.CamdenBoss.com		UNLESS OTHERWISE SPECIFIED: DIMENSIONS ARE IN MILLIMETERS		DO NOT SCALE DRAWING		REVISION. 0	
		GENERAL TOLERANCES +/- 0.2		TITLE: GENERAL ASSY FOR DRAWING 3400 SERIES			
		FINISH. TEXTURED		MATERIAL. UL94-V0		DWG NO. 3400-01	
DRAWN	JAMIE JACOBS	SIGNED	JNJ	DATE	08/11/12	SCALE: 3 : 4	
CHKD	-	-	-	-	-	SHEET 1 OF 1	

A4