

SECTION B-B

4x Ø 2.40 FOR SELF-TAPPING SCREWS

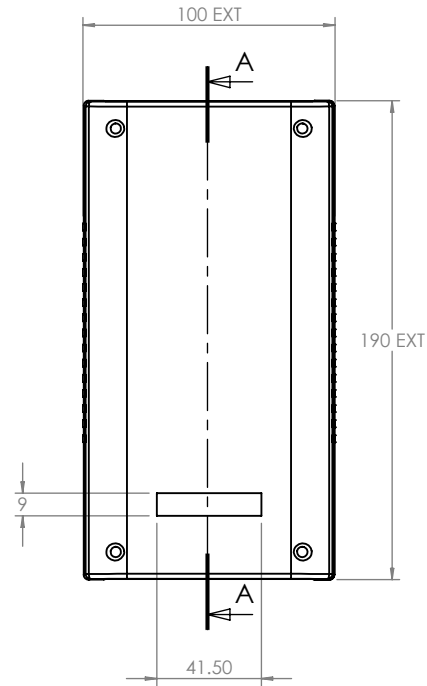

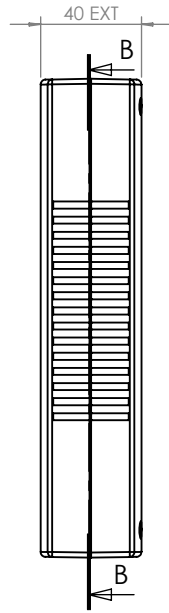
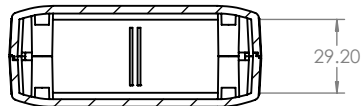
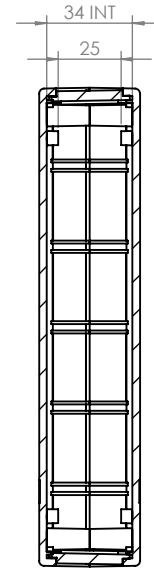

SECTION A-A

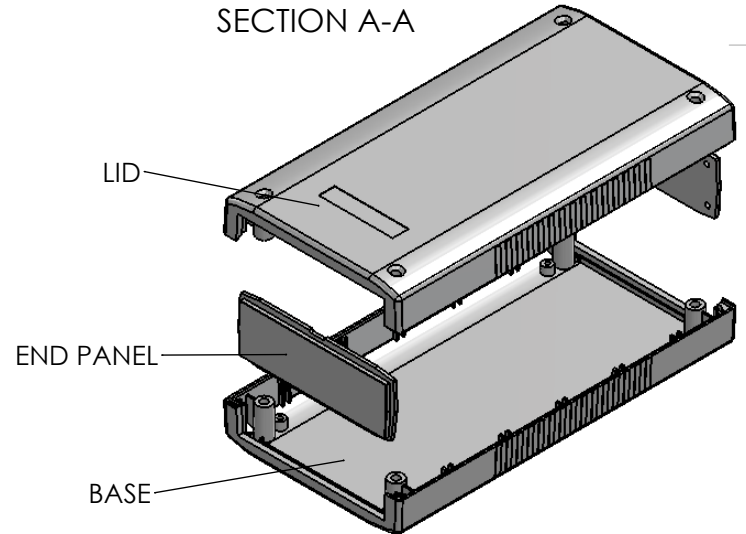
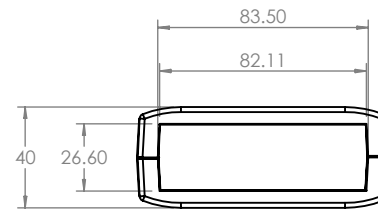

SECTION C-C



 CAMDENBOSS JAMES CARTER RD, MILDENHALL, SUFFOLK. IP28 7DE TEL: 01638 716101 FAX: 01638 716554 EMAIL: Sales@CamdenBoss.com WEB: www.CamdenBoss.com		UNLESS OTHERWISE SPECIFIED: DIMENSIONS ARE IN MILLIMETERS		DO NOT SCALE DRAWING		REVISION. 0			
		GENERAL TOLERANCES +/- 0.2		TITLE: GENERAL ASSY DRAWING FOR 3400 SERIES					
DRAWN		NAME	SIGNED	DATE	FINISH. TEXTURED		MATERIAL. UL94-V0	DWG NO. 3400-21	A4
CHKD		-	-	-	PROJECTION. 		SCALE. 1 : 3	SHEET 1 OF 1	