

SECTION B-B

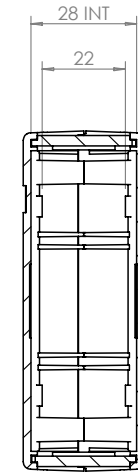

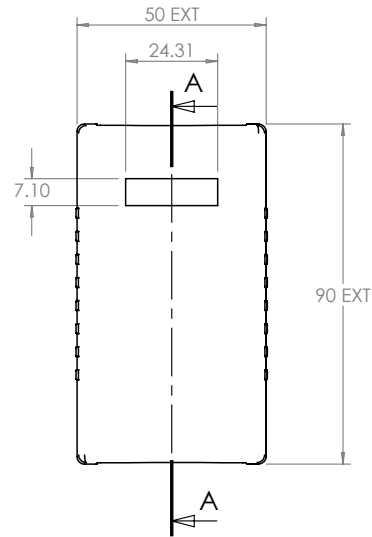

SECTION A-A

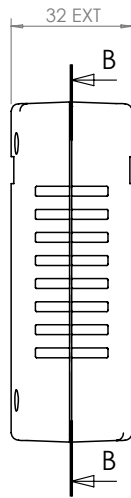
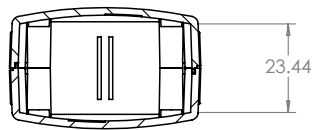

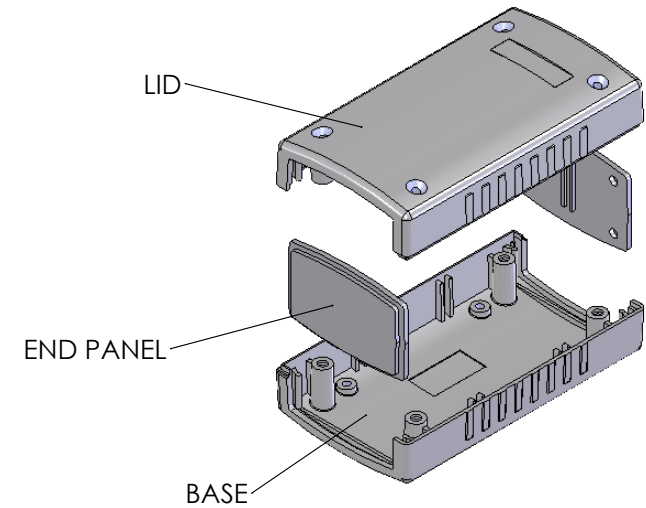
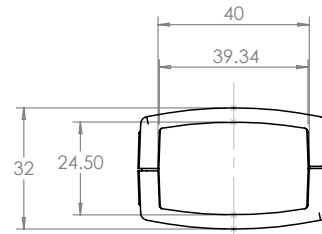
SECTION C-C



 CAMDENBOSS JAMES CARTER RD, MILDENHALL, SUFFOLK. IP28 7DE TEL: 01638 716101 FAX: 01638 716554 EMAIL: Sales@CamdenBoss.com WEB: www.CamdenBoss.com				UNLESS OTHERWISE SPECIFIED: DIMENSIONS ARE IN MILLIMETERS		DO NOT SCALE DRAWING		REVISION. 0	
				GENERAL TOLERANCES +/- 0.2		TITLE: GENERAL ASSY DRAWING FOR 3400 SERIES			
DRAWN L. SUBKHANKULOVA LS 01/04/11				FINISH. TEXTURED		MATERIAL. ABS		DWG NO. 3400-34	
CHKD - - -				PROJECTION. 		SCALE: 1 : 2		SHEET 1 OF 1	

A4