

OVERALL ASSEMBLY DIMENSIONS:

EXTERNAL - 99 x 52 x 28

INTERNAL - 71.75 x 45.5 x 25

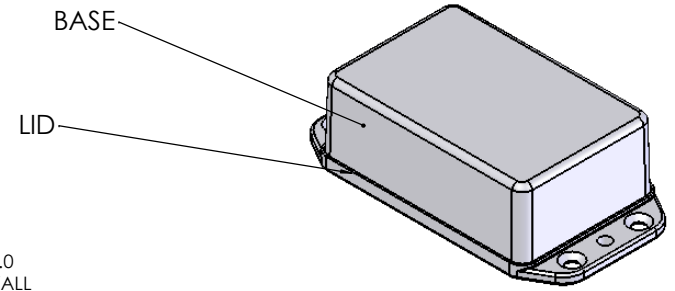

BASE

LID

ISO VIEW
1:2

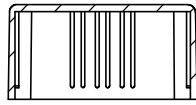

SECTION C-C

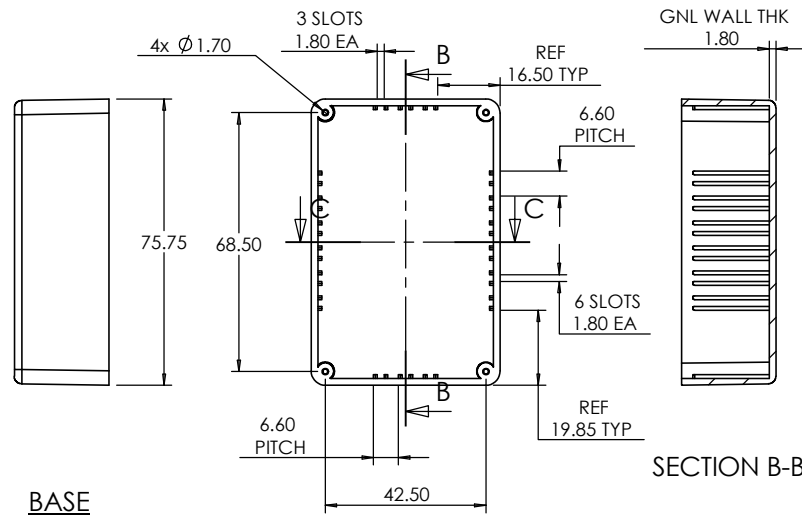
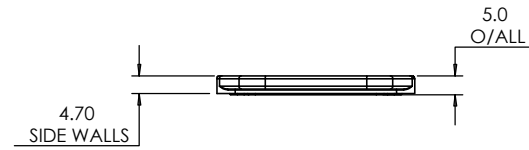

BASE

SECTION B-B

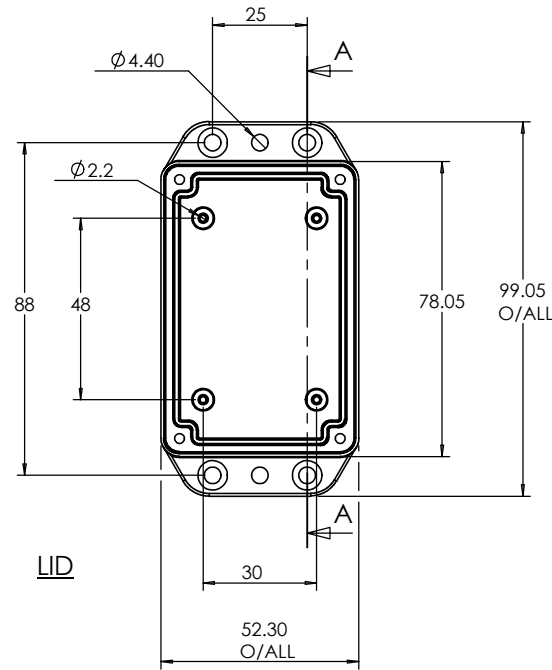

LID

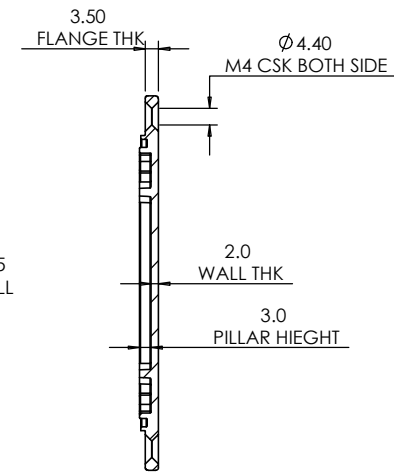

SECTION A-A

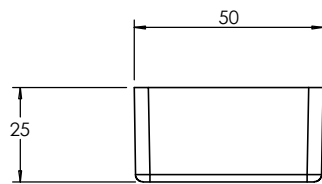

<p>CAMDENBOSS JAMES CARTER RD, MILDENHALL, SUFFOLK. IP28 7DE TEL: 01638 716101 FAX: 01638 716554 EMAIL: Sales@CamdenBoss.com WEB: www.CamdenBoss.com</p>				UNLESS OTHERWISE SPECIFIED: DIMENSIONS ARE IN MILLIMETERS		DO NOT SCALE DRAWING		REVISION. 0	
				FINISH. SMOOTH		TITLE: GNL ASSY DRG FOR IP 2000-SERIES ENCLOSURE			
DRAWN S.HARDINGE		SIGNED SJH		DATE 11/11/08		MATERIAL. ABS		DWG NO. 2000-IP	
CHK'D -		-		-		PROJECTION.		SCALE. 1:2	
								SHEET 1 OF 1	