

1 2 3 4 5 6

A

A

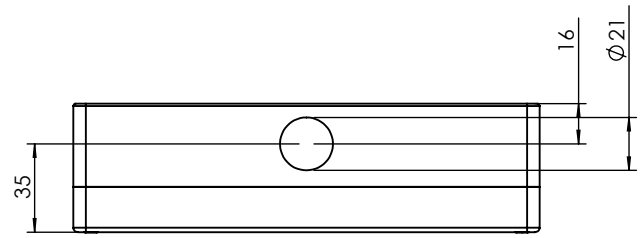

B

B

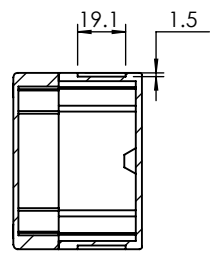

SECTION A-A  
Cut-out Dimensions

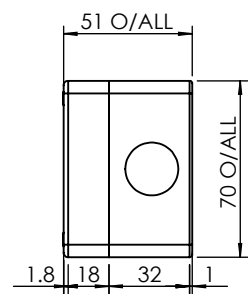
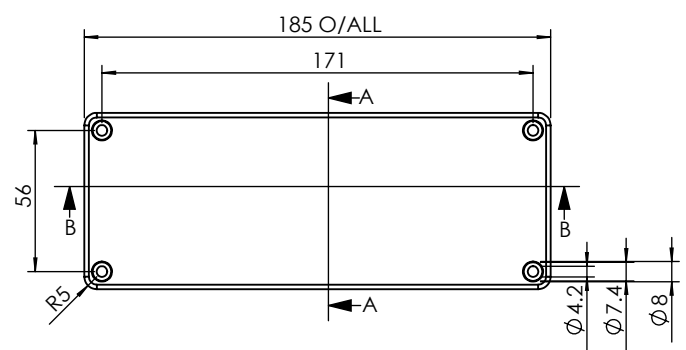

C

C

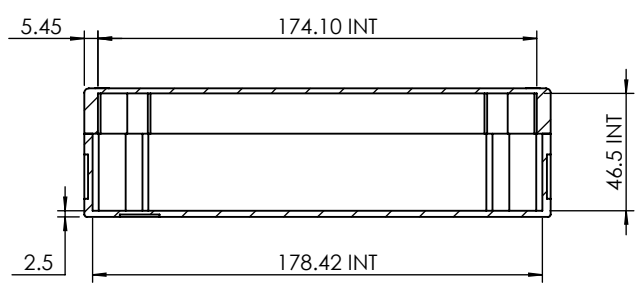

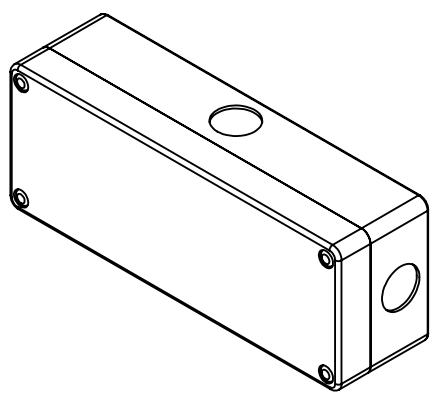

SECTION B-B

ISO VIEW  
1:3



D

D

 <b>CAMDENBOSS</b> JAMES CARTER RD, MILDENHALL, SUFFOLK. IP28 7DE TEL: 01638 716101 FAX: 01638 716554 EMAIL: Sales@CamdenBoss.com WEB: www.CamdenBoss.com		UNLESS OTHERWISE SPECIFIED: DIMENSIONS ARE IN MILLIMETERS	DO NOT SCALE DRAWING	REVISION. <input type="checkbox"/>
		GENERAL TOLERANCES +/- 0.2	TITLE: <b>GENERAL DIMENSION DRAWING FOR STANDARD CONTROL STATION ENCLOSURE</b>	
		FINISH. FINE TEXTURE	DWG NO. <b>CCS09GY00</b>	A4
DRAWN	LEWIS LETCHFORD	SIGNED	LL	DATE
CHK'D	-	SIGNED	-	DATE
		MATERIAL. ABS	SCALE. 1:3	SHEET 1 OF 1
		PROJECTION. 		

1 2 3