

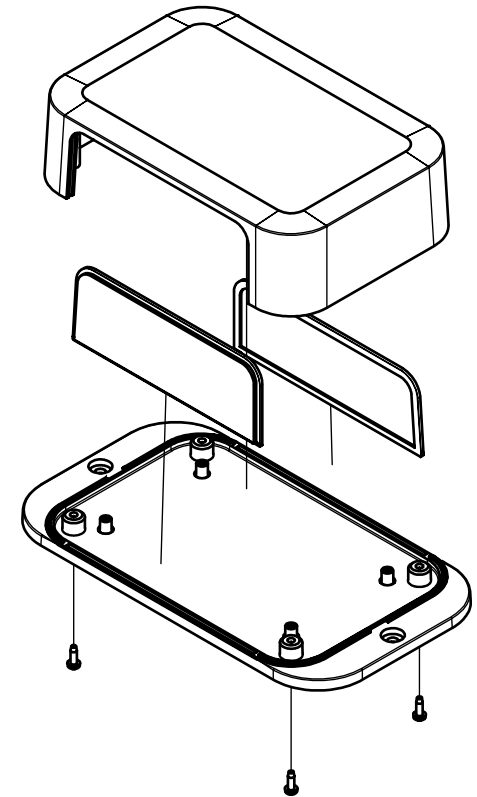

ISO VIEW
3:9



 CAMDENBOSS JAMES CARTER RD, MILDENHALL, SUFFOLK. IP28 7DE TEL: 01638 716101 FAX: 01638 716554 EMAIL: Sales@CamdenBoss.com WEB: www.CamdenBoss.com		UNLESS OTHERWISE SPECIFIED: DIMENSIONS ARE IN MILLIMETERS		GENERAL TOLERANCES +/- 0.2		REVISION. ○	
		FINISH: LIGHT SPARK		TITLE: 94 SERIES Flanged Comms Box Size 11 White 100.4x180.4x45			
DRAWN S.WHITEHEAD		SIGNED SW		DATE 15/06/017		MATERIAL: ABS UL94-VO	
CHK'D -		-		-		PROJECTION. 	
				DWG NO. CDE9411WH		A4	
				SCALE: 3:9		SHEET 1 OF 1	
						DO NOT SCALE DRAWING	