

Section A-A

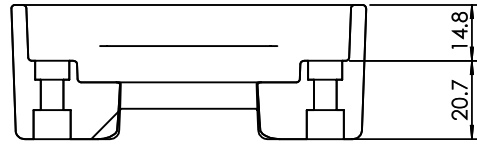

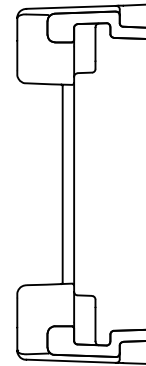

ISO VIEW

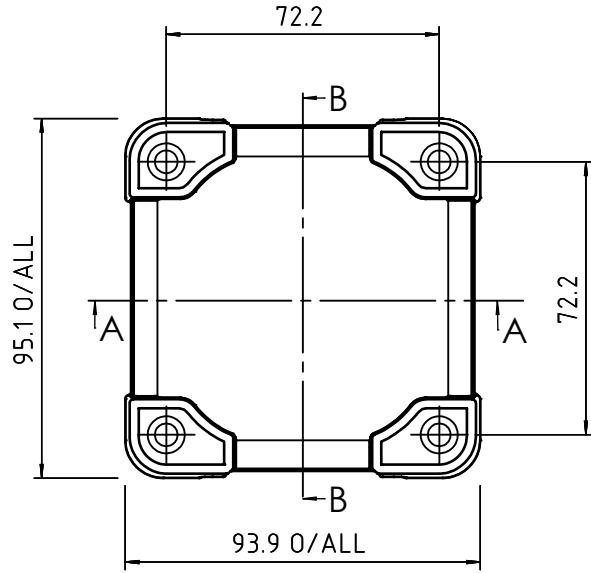
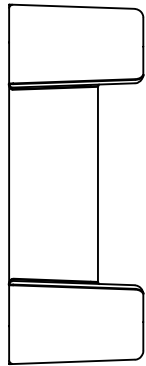
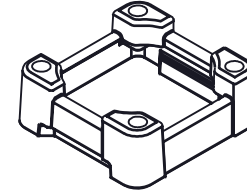

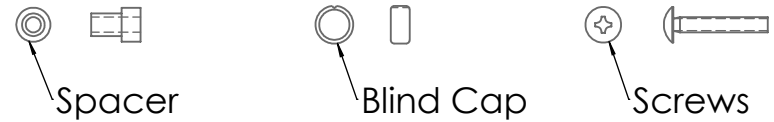
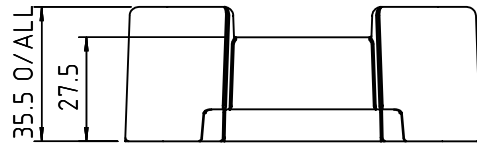
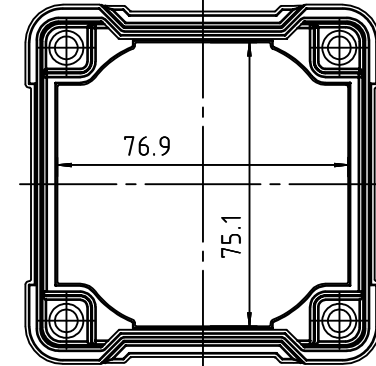
Section B-B



 CAMDENBOSS JAMES CARTER RD, MILDENHALL, SUFFOLK. IP28 7DE TEL: 01638 716101 FAX: 01638 716554 EMAIL: Sales@CamdenBoss.com WEB: www.CamdenBoss.com				UNLESS OTHERWISE SPECIFIED: DIMENSIONS ARE IN MILLIMETERS		DO NOT SCALE DRAWING		REVISION. <input type="checkbox"/>	
				GENERAL TOLERANCES +/- 0.2		TITLE: 88 SERIES SILICONE BOOTS, SIZE3, BLACK 93.9x95.1x35.5			
FINISH. SMOOTH				MATERIAL. SILICONE		DWG NO. CDM88B3BK		A4	
DRAWN	LEWIS LETCHFORD	L.L.	07/03/2014	PROJECTION. 		SCALE. 2:4		SHEET 1 OF 1	
CHK'D	-	-	-						