

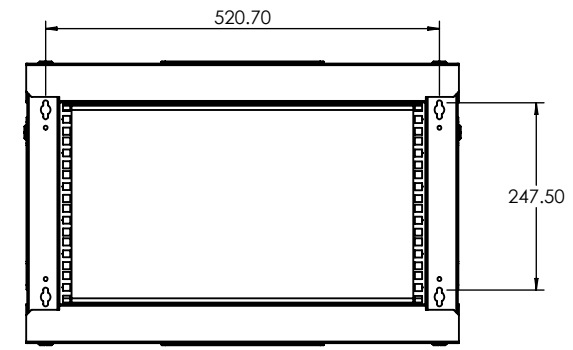

SECTION A-A

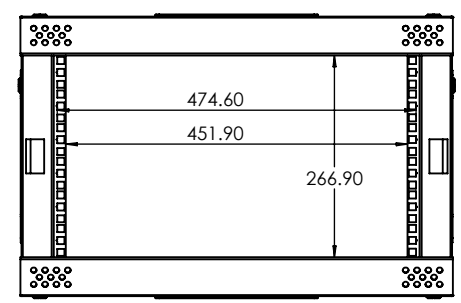

ISO VIEW  
1:20

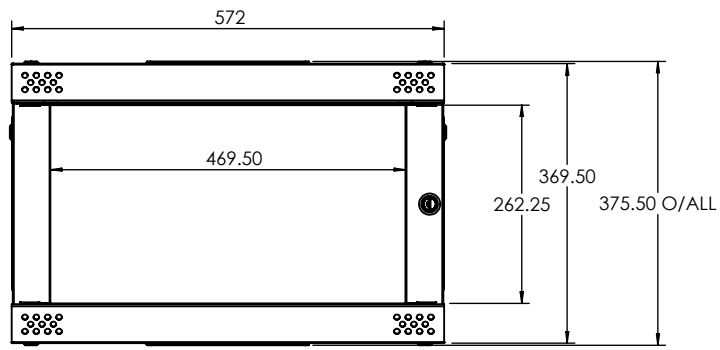
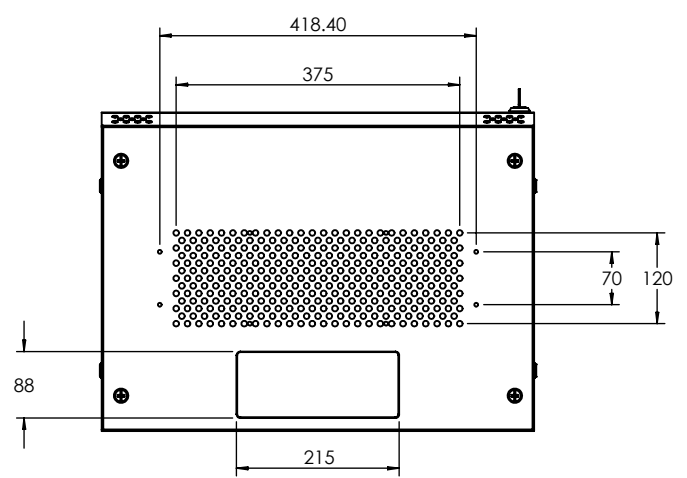
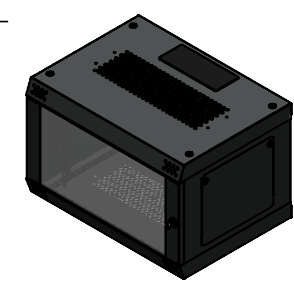

 <b>CAMDENBOSS</b> JAMES CARTER RD, MILDENHALL, SUFFOLK. IP28 7DE TEL: 01638 716101 FAX: 01638 716554 EMAIL: Sales@CamdenBoss.com WEB: www.CamdenBoss.com		UNLESS OTHERWISE SPECIFIED: DIMENSIONS ARE IN MILLIMETERS		DO NOT SCALE DRAWING		REVISION. 0	
		GENERAL TOLERANCES +/- 0.2		TITLE: <b>CAMRACK QX 6U</b>			
FINISH. <b>ANTHRACITE</b>		MATERIAL. <b>VAR</b>		DWG NO. <b>CBQX064211</b>		<b>A4</b>	
DRAWN	NAME IAN PAGANO	SIGNED I.P.	DATE 31/01/13	PROJECTION. 		SCALE: 1 : 2	
CHKD	-	-	-	SHEET 1 OF 1			