

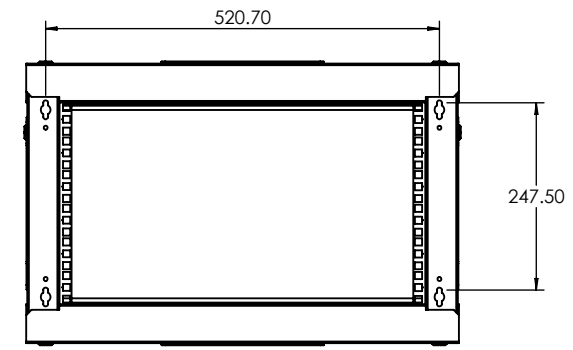

SECTION A-A

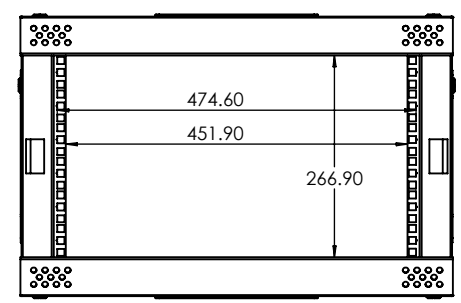

ISO VIEW
1:20

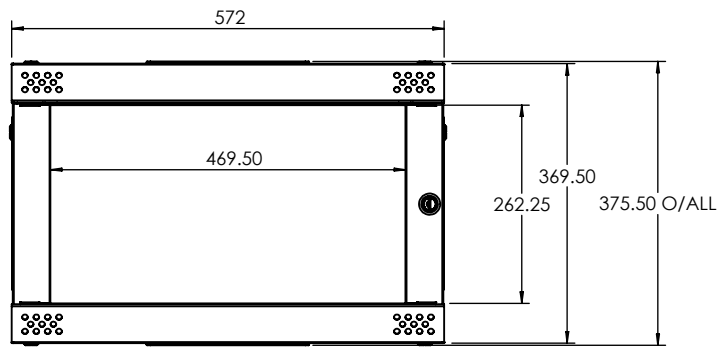
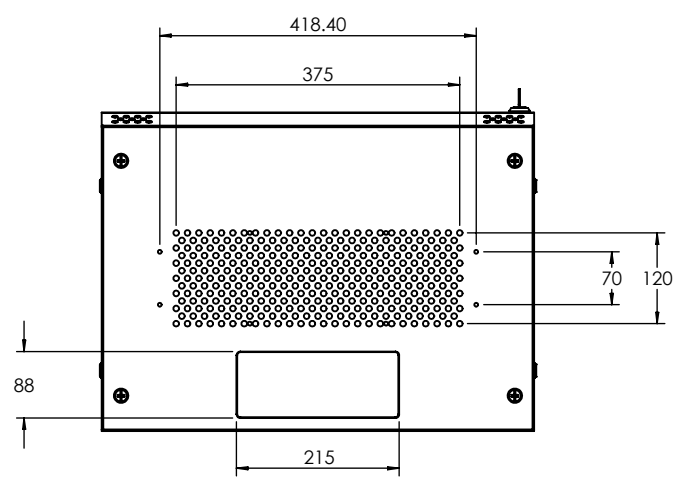
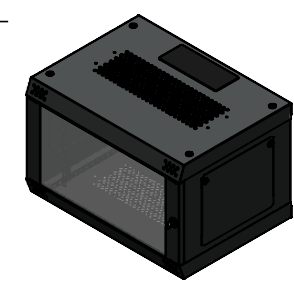

 CAMDENBOSS JAMES CARTER RD, MILDENHALL, SUFFOLK. IP28 7DE TEL: 01638 716101 FAX: 01638 716554 EMAIL: Sales@CamdenBoss.com WEB: www.CamdenBoss.com		UNLESS OTHERWISE SPECIFIED: DIMENSIONS ARE IN MILLIMETERS		DO NOT SCALE DRAWING		REVISION. 0	
		GENERAL TOLERANCES +/- 0.2		TITLE: CAMRACK QX 6U			
FINISH. ANTHRACITE		MATERIAL. VAR		DWG NO. CBQX064211		A4	
DRAWN	NAME IAN PAGANO	SIGNED I.P.	DATE 31/01/13	PROJECTION. 		SCALE: 1 : 2	
CHKD	-	-	-	SHEET 1 OF 1			