

1 2 3 4 5 6

A

B

C

D

A

B

C

D

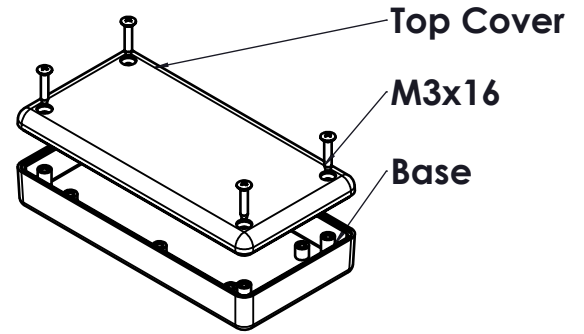
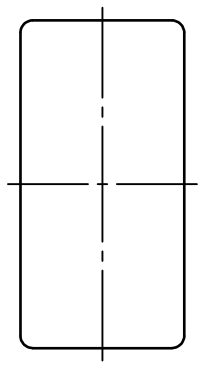
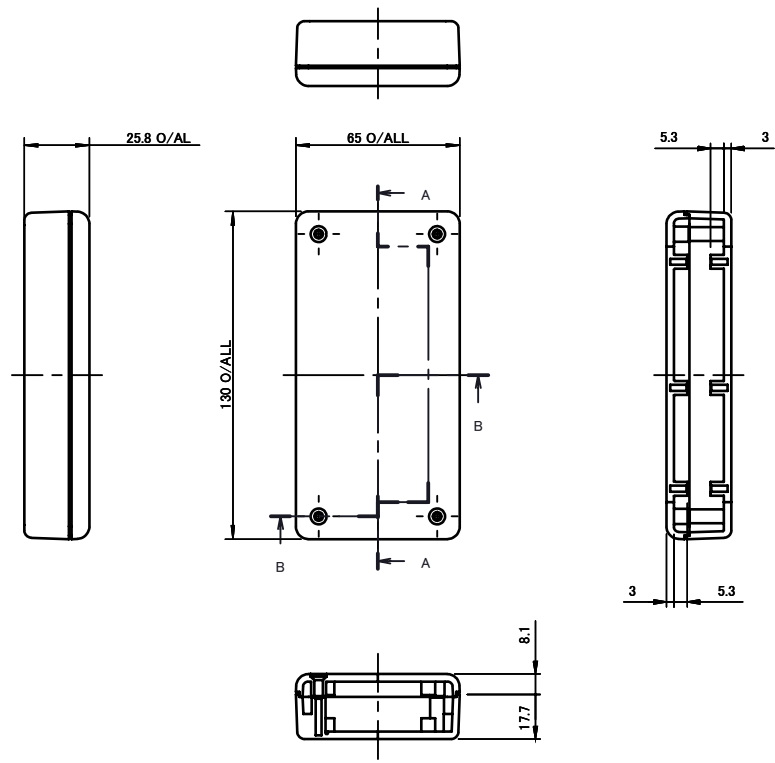

ISO VIEW
1:3

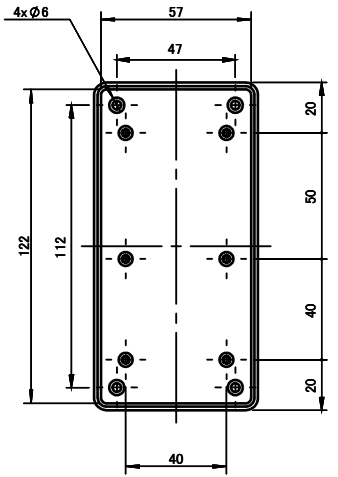
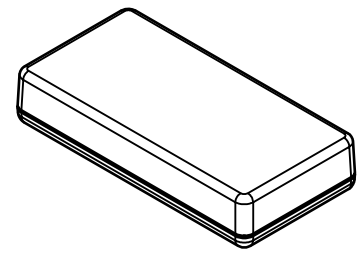

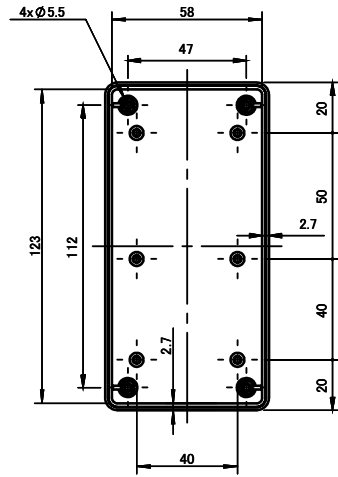

TOP



BASE

1 2 3

 CAMDENBOSS JAMES CARTER RD, MILDENHALL, SUFFOLK. IP28 7DE TEL: 01638 716101 FAX: 01638 716554 EMAIL: Sales@CamdenBoss.com WEB: www.CamdenBoss.com			UNLESS OTHERWISE SPECIFIED: DIMENSIONS ARE IN MILLIMETERS		DO NOT SCALE DRAWING		REVISION. <input type="checkbox"/>	
			GENERAL TOLERANCES +/- 0.2		TITLE: 82 SERIES MULTI-PURPOSE CASES, SIZE 11, BLACK, 130x65x25.8			
			FINISH. FINE TEXTURE		DWG NO.		CUE8211BK	
			MATERIAL. ABS UL94-V0		SCALE: 1:3		SHEET 1 OF 1	
DRAWN	LEWIS LETCHFORD	L.L.	29/01/2014	PROJECTION.			A4	
CHK'D	-	-	-					