

TOP VIEW

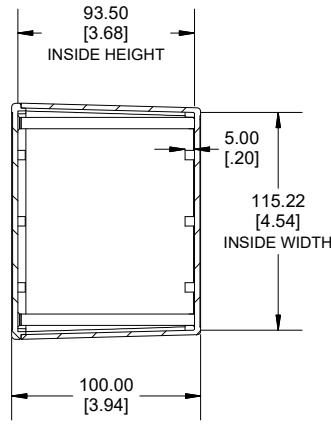

SECTION A-A  
END VIEW

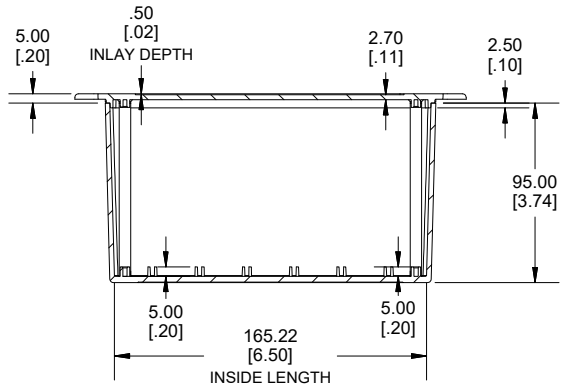

SECTION B-B  
SIDE VIEW

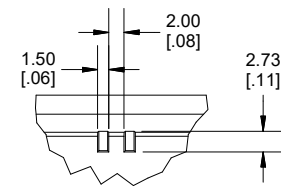

DETAIL C

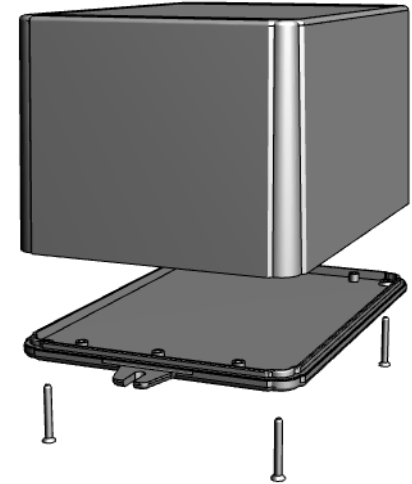

Enclosures can be Factory Modified (Milling, Drilling, Printing etc.)  
 Contact Factory (modshop@hammfg.com) for quotes  
 Solid models of this enclosure available in .stp or .x\_t  
 (Part number and text placement/orientation on our products are subject to change,  
 we do not recommend using them as a locating reference for modification purposes)

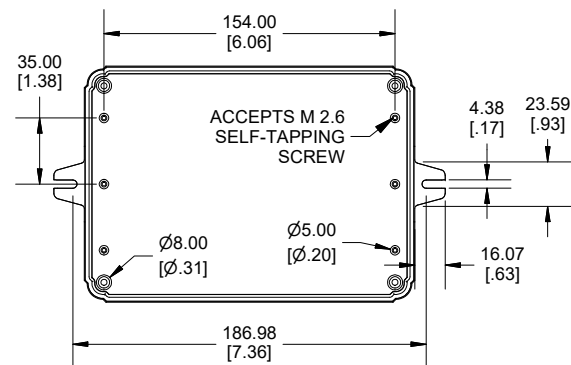

INSIDE LID

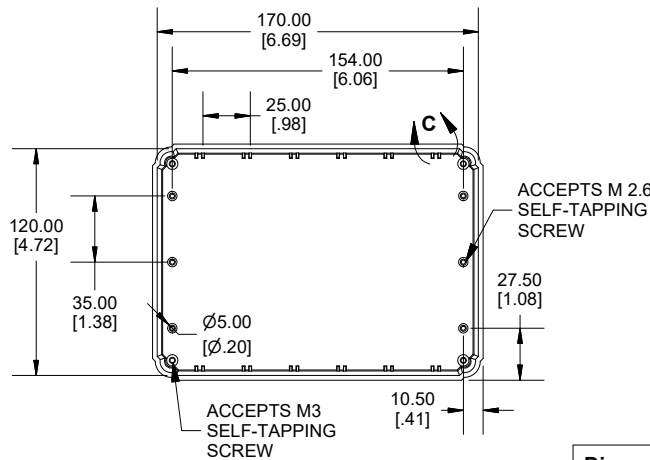

INSIDE BOX

Dimensions:  
 mm  
 [inches]

**NOTE**

Purchased assembly includes box, lid, 4 PCB screws, and 4 Lid screws.

Recommended Torque : (43-50) Ozf.in / (30-35) cN.m

**RL Enclosure**

General Purpose ABS Light Grey (UL94 HB)	RL6585F
General Purpose ABS Black (UL94 HB)	RL6585FBK

**ACCESSORIES**

Lid Screw (M3 X 25mm Self-tapping) (50 Pkg)	SC617-50
PCB Screw (M2.6 X 6mm Self-tapping) (50 Pkg)	SC519-50

**HAMMOND  
 MANUFACTURING**

**RL6585F**

www.hammondmfg.com