

OVERALL ASSEMBLY DIMENSIONS:

EXTERNAL - 50 x 50 x 31
 INTERNAL - 46.4 x 46.4 x 26.8

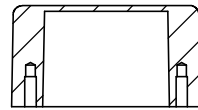

SECTION B-B

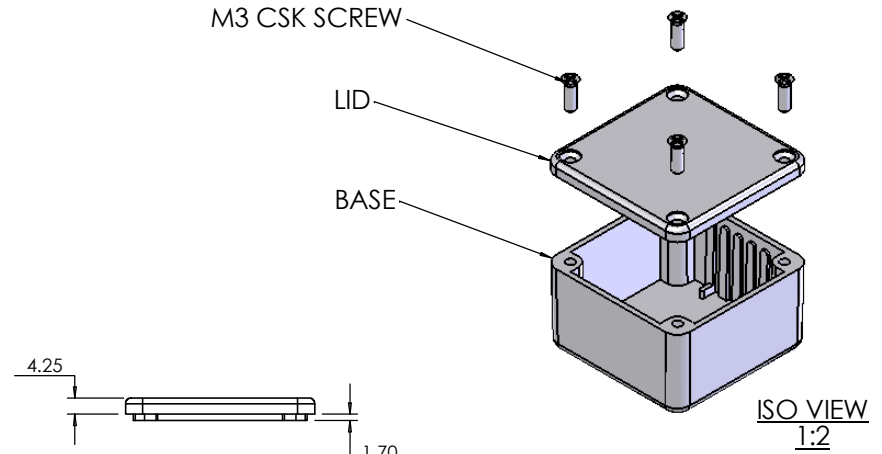

ISO VIEW
1:2

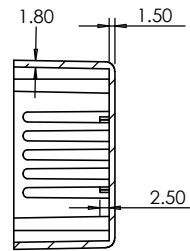
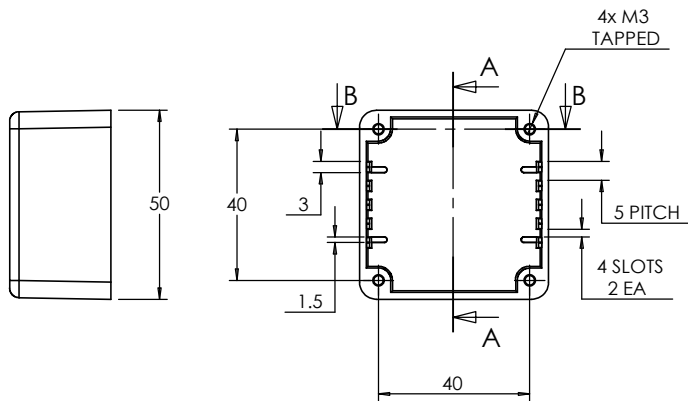

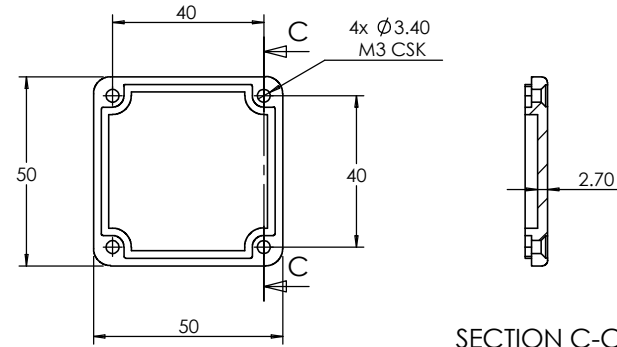

SECTION A-A

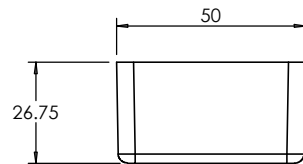

SECTION C-C



LID

 CAMDENBOSS JAMES CARTER RD, MILDENHALL, SUFFOLK, IP28 7DE TEL: 01438 716101 FAX: 01438 716554 EMAIL: Sales@CamdenBoss.com WEB: www.CamdenBoss.com				UNLESS OTHERWISE SPECIFIED: DIMENSIONS ARE IN MILLIMETERS		DO NOT SCALE DRAWING	REVISION. 0
				FINISH. SMOOTH		TITLE: ASSEMBLY DRG FOR 5001/11	
DRAWN	S.HARDINGE	SJH	07/12/05	MATERIAL. DIE-CAST ALUMINIUM	DWG NO.	5001,11	A4
CHK'D	-	-	-	PROJECTION. 	SCALE: 1:2	SHEET 1 OF 1	